

# B 17

## Granulators

**Mod. B17-22-3K**

**Mod. B17-38-3K**



### Caratteristiche tecniche

- Realizzati per applicazioni bordopressa (iniezione e soffiaggio).
- Rotore aperto 3k.
- Tramoggia reversibile.
- Basso numero di giri del rotore (250 G/MIN).
- Dischi laterali che ruotano assieme al rotore.
- Griglia in acciaio Inox.
- Apertura rapida e facilità di pulizia.

### Technical data

- Designed for beside the press operation (injection and blow moulding).
- 3 knives open rotor.
- Reversible hopper.
- Slow rotor speed (250 RPM).
- Lateral end discs which turn with the rotor.
- Standard screen in stainless steel.
- Quick opening and easy cleaning.

### applications





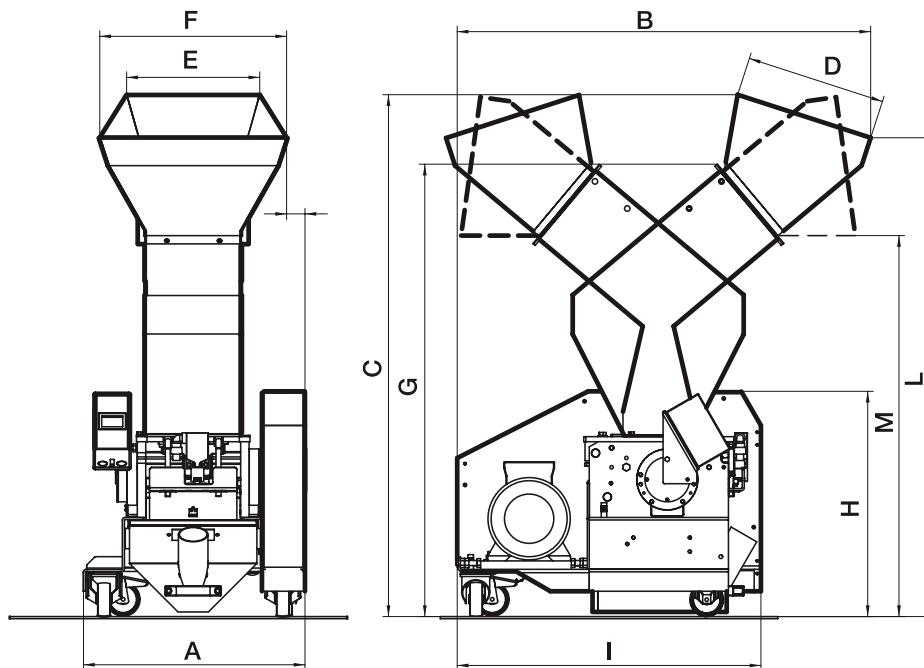



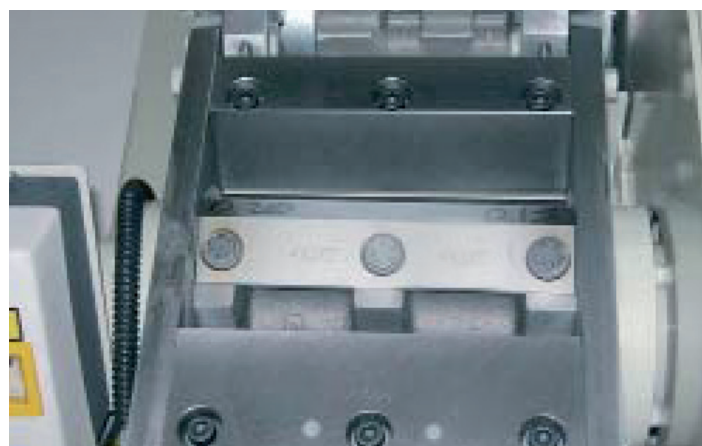
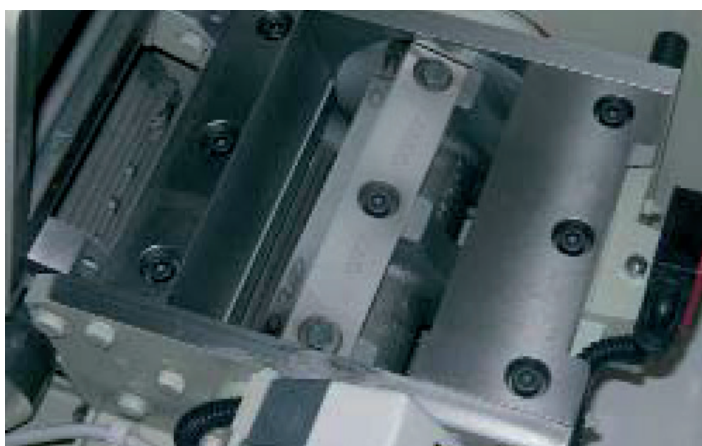

[www.cmg.it](http://www.cmg.it)



	A	B	C	D	E	F	G	H	I	L	M
<b>B17-22-3K</b>	525	980	1237	327	316	443	1072	534	720	1135	903
<b>B17-38-3K</b>	675	980	1237	327	465	593	1072	534	720	1135	903



	 mm	 n°	 n°	 mm	 RPM	 KW	 Ø mm	 Kg/H
<b>B17-22-3K</b>	327x315	3	2	170	250	2,2	5	30-50
<b>B17-38-3K</b>	327x465	3	2	170	250	2,2	5	50-90